

Modeling with Ubbink Air Excellent

This manual describes how you can model with the product line of Ubbink Air Excellent in Revit 2016, 2017 or 2018. While drawing, the correct fittings (bends and connectors) are automatically inserted. In the template you can also find special fittings and equipment that you can place separately.

Installation

To draw with the product line of Ubbink Air Excellent, open the file *Ubbink Air Excellent Template INT.rvt*. This Revit template contains the product line and a number of predefined schedules.

If you want to draw in an existing project, you can copy the product line using *Transfer Project Standards* in Revit. That is done in the following way:

1. Open the existing project and the Ubbink template.
2. Activate the existing project.
3. On the tab *Manage*, panel *Settings*, select *Transfer Project Standards*.
4. At *Copy from*;, select the template file, check the items as in the image below and click OK.

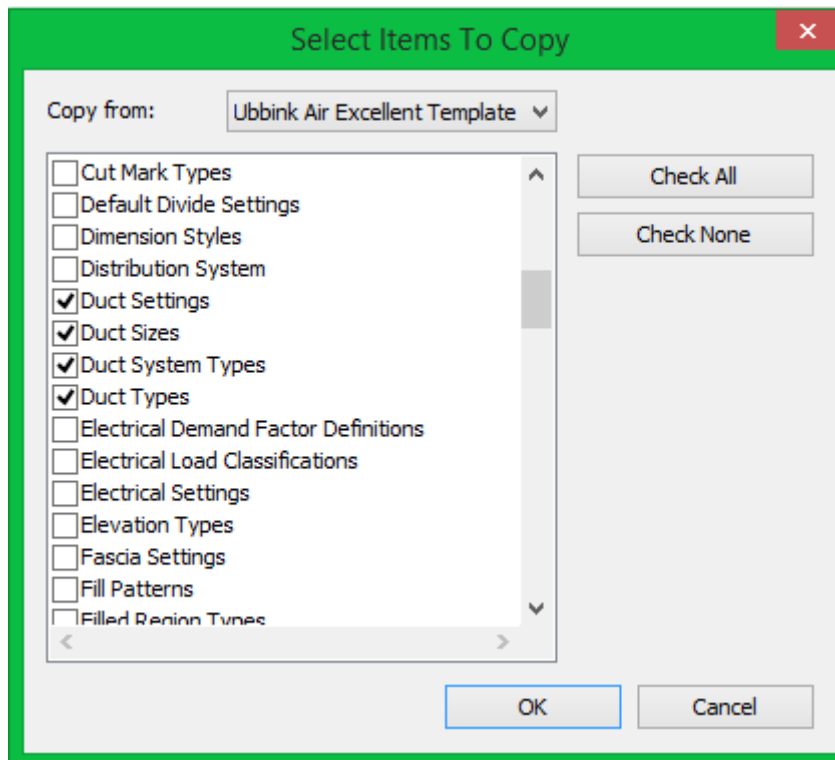

5. The product line is transferred from the template to the existing project.

Draw

When the product line is in the project, you can draw a duct system the way you are used to via *Systems > Duct*. In *Properties*, select the product line and dimensions.

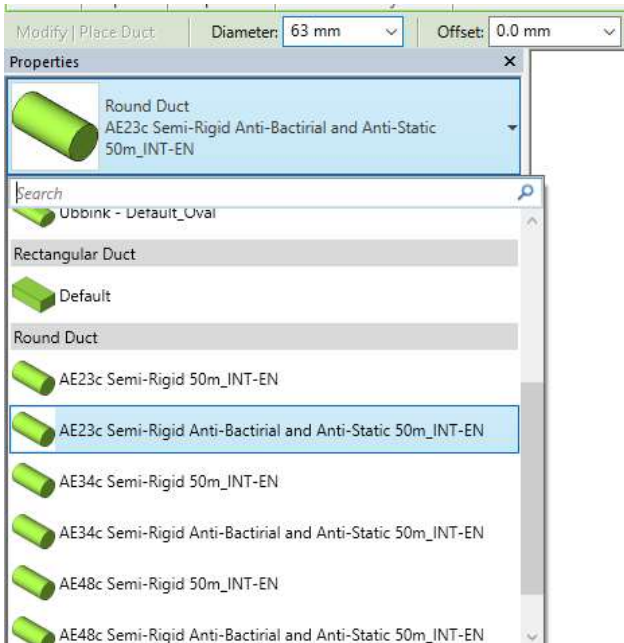

Next, model the system. Ubbink Air Excellent fittings with the correct article number are automatically added while drawing. Changing the ducts can be done the way you are used to in Revit: select the ducts and change the dimensions. The fittings are automatically adjusted.

For circular ducts a 90° bend is available in autorouting. However if the system is drawn at different angles a custom bend will be generated. As these bends do not really exist they are marked red in the model.

Schedules

The template contains four schedules for bills of materials for the equipment, fittings, ducts and air terminals:

- VE_General_BOM_Air Terminal
- VE_General_BOM_Duct Accessories
- VE_General_BOM_Duct Fittings
- VE_General_BOM_Ducts

<VE_General_BOM_Duct Accessories>								
A	B	C	D	E	F	G	H	I
Manufacturer	Article Type	Article Description	Diameter	Diameter 1	Width 1	Height 1	Manufacturer Art.No.	GTR
Ubbink	AE23c	Includes 2 caps	125	63			0188175	
Ubbink	AE23c	Includes 2 caps	125	63			0188176	
Ubbink	AE35ec	Includes 1 cap	125		102	50	0188300	8713645174990
Ubbink	AE23c	Includes 1 cap	125	63			0188341	8713645201412
Ubbink	AE34c	Includes 1 cap	125	75			0188342	8713645201429

Hints

1. The ratio of the dimensions of semi-circular ducts should be manually defined. Ubbink Air Excellent material is only available in 50x102 and 60x132 (height x width). Please note that the manufacturer indicates these dimensions to be 50x100 and 60x130. In Revit you can make all combinations using this dimensions, however families with other combinations will not work. An error message (*Can't make type*) will then be generated by Revit.
2. Families that do not have a preview in the *Properties* window are *shared components*.
3. The reducer from circular to semi-circular, only available for 132x60 mm to 90 mm and vice versa, cannot be connected directly to a duct on the semi-circular side. A socket or a horizontal or vertical bend is needed here. In order to create the correct combination, the auto-routing settings should be adjusted:

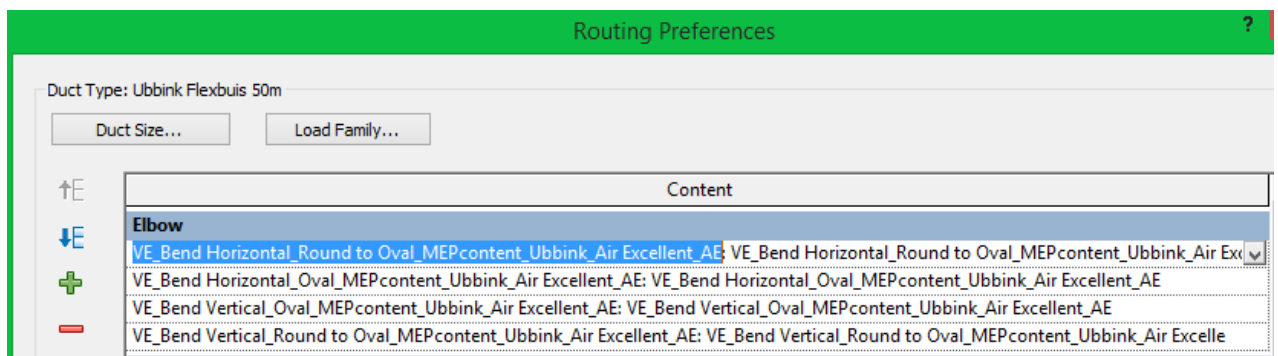

After drawing the reducer, restore the previous settings.

As both the bend and the reducer contain sealing rings, and they are only needed on one side, one of these should be hidden. This will be the one in the bend, because the one in the reducer is fixed. In order to do this, select the bend and uncheck the parameter *Coupling 1* or *Coupling 2*, depending on the side of the bend the reducer is placed in.

4. The air distribution box can be used with various adapters: round to round or circular to semicircular. The adapters can be connected to the air distribution box by making them *snap* to the appropriate adapter. (the ducts can be connected by the available adapters for the round or semi-round system to the various variants of the air distribution boxes)

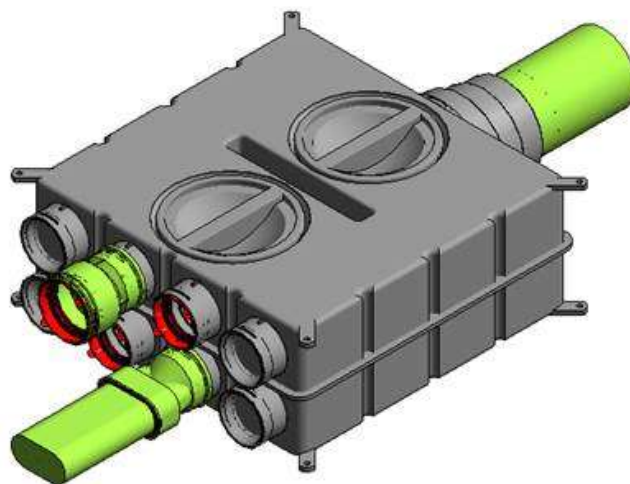

- For distribution boxes, you can choose to add a restrictor (which will be placed on the inside) or set an end cap on or off to any connection. You can also adjust the diameter and position of the main connection.

Visibility	
Restrictor 1	<input type="checkbox"/>
Cap 1	<input checked="" type="checkbox"/>

Properties

 VE_Distribution Box_MEPcontent_Ubbink_Air Excellent_AE8 AE8

Duct Accessories (1) Edit Type

Visibility	
Top Front Connection	<input type="checkbox"/>
Top Front Cap	<input checked="" type="checkbox"/>
Top Back Connection	<input type="checkbox"/>
Top Back Cap	<input checked="" type="checkbox"/>
Bottom Front Connection	<input type="checkbox"/>
Bottom Front Cap	<input checked="" type="checkbox"/>
Bottom Back Connection	<input type="checkbox"/>
Bottom Back Cap	<input checked="" type="checkbox"/>
180 Connection	<input type="checkbox"/>
160 Connection	<input type="checkbox"/>
150 Connection	<input type="checkbox"/>
125 Connection	<input checked="" type="checkbox"/>

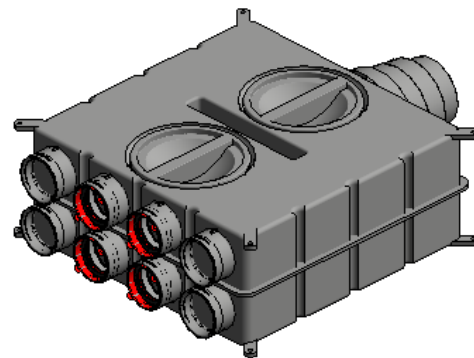

Note

All Distribution Boxes available inside the template, have the options to check or uncheck restrictors and caps. As products when placing an order the distribution boxes contains an restricted number of caps and restrictors as shown in the schedule below :

<VE_General_BOM_DuctAccessories>								
A	B	C	D	E	F	G	H	I
Manufacturer	Article Type	Article Description	Diameter	Capable 1	Width 1	Height 1	Manufacturer Article	GTN
Ubbink	DBOX016	Includes stepped adaptor DN125-100, 3 caps and 16 air restrictor rings	125	75			0100501	0713045215430
Ubbink	DBOX008	Includes stepped adaptor DN125-100, 4 caps and 8 air restrictor rings	125	75			0100503	0713045215440
Ubbink	DBOX216V	Includes stepped adaptor DN125-100, 3 caps and 16 air restrictor rings	125	75			0100601	0713045217000
Ubbink	DBOX212V	Includes stepped adaptor DN125-100, 0 caps and 12 air restrictor rings	125	75			0100602	0713045217100
Ubbink	DBOX208H DH106	Includes wire adaptor DN100, 3 caps and 8 air restrictor rings	100	75			0100641	0713045216000
Ubbink	DBOX208H	Includes stepped adaptor DN125-100, 3 caps and 8 air restrictor rings	125	75			0100644	0713045216000

If you have more options checked for a distribution box then the ones specified in the description, all extra articles will be ordered separately.

- Flexible semi-circular ducts AE55sc (article number 0188372) and AE35sc (article number 0188370) have a length of 20m. Circular ducts AE48c (article number 0188379) have a length of 50 m. For other roll lengths see the delivery program of Ubbink.



Questions or remarks?





Contact us via the form at www.mepcontent.eu or via info@mepcontent.eu.

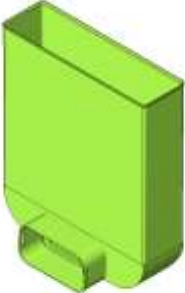



Available articles



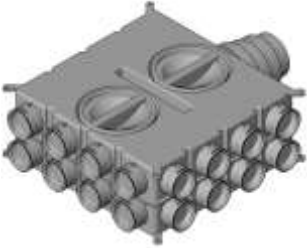
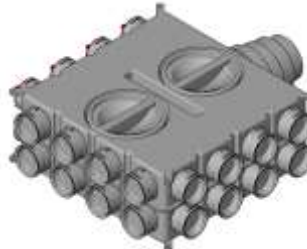

Art. No.	Description	Image
0188396	Universal Mounting Clip (1 box of 10) <i>VE_Bracket_F_MEPcontent_Ubbink_Air Excellent_AE_INT-EN.rfa</i>	
0188573 0188577	Includes 2 seal rings <i>E_Bend Vertical_Oval_MEPcontent_Ubbink_Air Excellent_AE35sc - AE55sc_INT-EN.rfa</i>	
0188572 0188576	Includes 2 seal rings <i>VE_Bend Horizontal_Oval_MEPcontent_Ubbink_Air Excellent_AE35sc - AE55sc_INT-EN.rfa</i>	
0188571 0188575	Includes 2 seal rings <i>VE_Connection Piece_Oval_MEPcontent_Ubbink_Air Excellent_AE35sc - AE55sc_INT-EN.rfa</i>	
0188305 0188155	AE35sc-AE55sc Duct Accessory Cap <i>VE_End Piece_MEPcontent_Ubbink_Air Excellent_AE35sc-AE55sc_INT-EN.rfa</i>	
0188555	AE55sc DBOX Adaptor <i>VE_Connection Piece_Oval to Round_MEPcontent_Ubbink_Air Excellent_AE55sc_INT-EN.rfa</i>	



<p>0188302 0188152</p>	<p>AE35sc – AE55sc Seal Ring <i>VE_Seal Ring_MEPcontent_Ubbink_Air Excellent_AE35sc-AE55sc_INT-EN.rfa</i></p>	
<p>0188300</p>	<p>Valve adapter 90° DN125-50x100 for semi-circular ducts for AE35sc <i>VE_Connection Piece_Round Control_MEPcontent_Ubbink_Air Excellent_AE35sc 90_INT-EN.rfa</i></p> <p>Note: this article includes 1 end cap.</p>	
<p>0188150</p>	<p>Valve adapter 90° DN125-60x130 for semi-circular ducts AE55sc <i>VE_Connection Piece_Round Control_MEPcontent_Ubbink_Air Excellent_AE55sc 90_INT-EN.rfa</i></p> <p>Note: this article includes 1 end cap.</p>	
<p>0188164</p>	<p>Valve adapter 180° DN125-60x130 for semi-circular ducts for AE55sc <i>VE_Connection Piece_Round Control_MEPcontent_Ubbink_Air Excellent_AE55sc 180_INT-EN.rfa</i></p> <p>Note: this article includes 1 end cap.</p>	
<p>0188310</p>	<p>Valve adapter 180° DN125-50x100 for semi-circular ducts for AE35sc <i>VE_Connection Piece_Round Control_MEPcontent_Ubbink_Air Excellent_AE35sc 180_INT-EN.rfa</i></p> <p>Note: this article default has 1 end cap.</p>	





0188176	<p>Valve adapter 180° DN125-50x100 for semi-circular ducts for AE23sc <i>VE_Connection Piece_Round Control_MEPcontent_Ubbink_Air Excellent_AE23c 180_INT-EN.rfa</i></p> <p>Note: this article includes 2 caps</p>	
0188158	<p>Floor grill adapter, 60x130 for AE55sc <i>VE_Floor Grille_Adaptor_MEPcontent_Ubbink_Air Excellent_AE55sc 180_INT-EN.rfa</i></p>	
0188308	<p>Floor grill adapter, 50x100 for AE35sc <i>VE_Floor Grille_Adaptor_MEPcontent_Ubbink_Air Excellent_AE35sc.rfa</i></p> <p>Note: this article default has 1 end cap.</p>	
188397	<p>AE34c floor grille adaptor <i>VE_Floor Grille_Adaptor_MEPcontent_Ubbink_Air Excellent_AE34c_INT-EN.rfa</i></p> <p>Note: this article default has 1 end cap.</p>	

<p>0188538</p>	<p>Transition piece circular to semi-circular duct AE55sc – AE48c <i>VE_Reducer_Oval to Round_MEPcontent_Ubbink_Air Excellent_AE48c-AE55sc_INT-EN.rfa</i></p> <p>Note: this article includes 1 AE48c seal ring, 1 AE48c click ring and 1 AE55sc seal ring.</p>	
<p>0188316 0188317</p>	<p>Floor grille white/stainless steel <i>VE_Air Terminal_Grille_MEPcontent_Ubbink_Air Excellent_Floor Grate_INT-EN.rfa</i></p>	
<p>0188049</p>	<p>Extract ventilation valve <i>VE_Ventilation Valve_MEPcontent_Ubbink_Air Excellent_AE_Exhaust_INT-EN.rfa</i></p>	
<p>0188319</p>	<p>Supply ventilation valve <i>VE_Ventilation Valve_MEPcontent_Ubbink_Air Excellent_AE_Supply_INT-EN.rfa</i></p>	
<p>0188583</p>	<p>Distribution box DN75, 8 connections <i>VE_Distribution Box_MEPcontent_Ubbink_Air Excellent_DB808_INT-EN.rfa</i></p> <p>Note: this article includes stepped adaptor DN125-180, 4 caps and 8 air restrictor rings</p>	



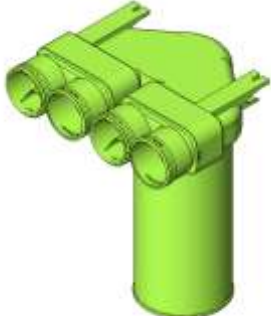

<p>(0188581 1 ξ ξ ξ ξ 1</p>	<p>Distribution box DN75, 16 connections <i>VE_Distribution Box_MEPcontent_Ubbink_Air Excellent_DB816_INT-EN.rfa</i></p> <p>Note: this article includes stepped adaptor DN125-180, 8 caps and 16 air restrictor rings</p>	
<p>0188588</p>	<p>DBOX 24x <i>VE_Distribution Box_MEPcontent_Ubbink_Air Excellent_DB824_INT-EN.rfa</i></p> <p>Note: this article includes stepped adaptor DN125-180, 20 caps and 20 air restrictor rings</p>	
<p>0188555</p>	<p>AE55sc DBOX adaptor <i>VE_Connection Piece_Oval to Round_MEPcontent_Ubbink_Air Excellent_AE55sc_INT-EN.rfa</i></p>	
<p>0188564</p>	<p>Air restrictor for circular ducts <i>VE_Restrictor_MEPcontent_Ubbink_Air Excellent_Restrictor_INT-EN.rfa</i></p>	
<p>0188563</p>	<p>Connection cover for circular ducts <i>VE_End Piece_MEPcontent_Ubbink_Air Excellent_DBOX Cover_INT-EN.rfa</i></p>	

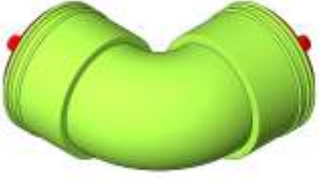

<p>0188347</p>	<p>Sealing ring for circular ducts for AE23c <i>VE_Seal Ring_MEPcontent_Ubbink_Air Excellent_AE23c_INT-EN.rfa</i></p> <p>Note: comes in 10 piece packs.</p>	
<p>0188366</p>	<p>Sealing ring for circular ducts for AE48c <i>VE_Seal Ring_MEPcontent_Ubbink_Air Excellent_AE48c_INT-EN.rfa</i></p> <p>Note: comes in 10 piece packs.</p>	
<p>0188390</p>	<p>Click ring for circular ducts for AE23c <i>VE_Connection Piece_Click Ring_MEPcontent_Ubbink_Air Excellent_AE23c_INT-EN.rfa</i></p> <p>Note: comes in 10 piece packs.</p>	
<p>0188391</p>	<p>Click ring for circular ducts for AE34c <i>VE_Connection Piece_Click Ring_MEPcontent_Ubbink_Air Excellent_AE34c_INT-EN.rfa</i></p> <p>Note: comes in 10 piece packs.</p>	
<p>0188392</p>	<p>Click ring for circular ducts for AE48c <i>VE_Connection Piece_Click Ring_MEPcontent_Ubbink_Air Excellent_AE48c_INT-EN.rfa</i></p> <p>Note: comes in 10 piece packs.</p>	

<p>0188341</p>	<p>Valve adapter 90° DN125 for circular ducts for AE23c <i>VE_Connection Piece_Round Control_MEPcontent_Ubbink_Air Excellent_AE23c_INT-EN.rfa</i></p> <p>Note: this article default has 1 end cap.</p>	
<p>0188342</p>	<p>Valve adapter 90° DN125 for circular ducts for AE34c <i>VE_Connection Piece_Round Control_MEPcontent_Ubbink_Air Excellent_AE34c_INT-EN.rfa</i></p> <p>Note: this article default has 1 end cap.</p>	
<p>0188380</p>	<p>Valve adapter 90° DN125 for circular ducts for AE48c <i>VE_Connection Piece_Round Control_MEPcontent_Ubbink_Air Excellent_AE48c_INT-EN.rfa</i></p> <p>Note: this article default has 1 end cap.</p>	

<p>0188175</p>	<p>Valve adapter 90° DN125 for circular ducts for AE23c <i>VE_Connection Piece_Round_Control_MEPcontent_Ubbink_Air Excellent_AE23c 90_INT-EN.rfa</i></p> <p>Note: this article includes 2 caps</p>	
<p>188350</p>	<p>AE34c straight connector <i>VE_Connection Piece_Round_MEPcontent_Ubbink_Air Excellent_AE23c_INT-EN.rfa</i></p> <p>Note: this article includes 2 AE23c seal and click rings</p>	
<p>0188579</p>	<p>AE34c straight connector <i>VE_Connection Piece_Round_MEPcontent_Ubbink_Air Excellent_AE34c_INT-EN.rfa</i></p> <p>Note: this article includes 2 AE34c seal and click rings</p>	
<p>0188569</p>	<p>AE48c Connector flex-flex for circular ducts <i>VE_Connection Piece_Round_MEPcontent_Ubbink_Air Excellent_AE48c_INT-EN.rfa</i></p> <p>Note: this article includes 2 AE48c seal and click rings</p>	

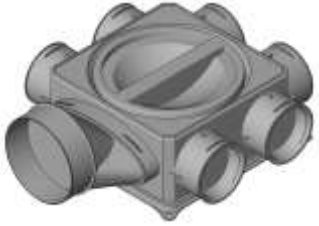
0188345	Cap for circular ducts for AE48c <i>VE_End Piece_MEPcontent_Ubbink_Air Excellent_AE23c_INT-EN.rfa</i>	
0188346	Cap for circular ducts for AE48c <i>VE_End Piece_MEPcontent_Ubbink_Air Excellent_AE34c_INT-EN.rfa</i>	
0188381	Cap for circular ducts for AE48c <i>VE_End Piece_MEPcontent_Ubbink_Air Excellent_AE48c_INT-EN.rfa</i>	
0188172	AE23c bend 90 <i>VE_Bend_Round_MEPcontent_Ubbink_Air Excellent_AE23c_INT-EN.rfa</i>	
0188599	AE34c bend 90 <i>VE_Bend_Round_MEPcontent_Ubbink_Air Excellent_AE34c_INT-EN.rfa</i>	

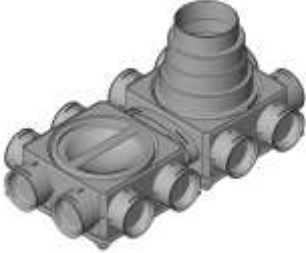
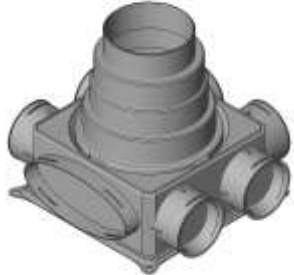
0188600	<p>AE48c bend 90 <i>VE_Bend_Round_MEPcontent_Ubbink_Air_Excellent_AE48c_INT-EN.rfa</i></p>	
0188553	<p>Transition piece circular for AE48c <i>VE_Connection_Piece_Round_MEPcontent_Ubbink_Air_Excellent_AE48c_DBOX_INT-EN.rfa</i></p>	
0188553	<p>Transition piece circular for AE23c <i>VE_Connection_Piece_Round_MEPcontent_Ubbink_Air_Excellent_AE23c_DBOX_INT-EN.rfa</i></p>	
0188537	<p>AE34c - AE35sc adaptor <i>VE_Bend_Vertical_Round_to_Oval_MEPcontent_Ubbink_Air_Excellent_AE34c-AE35sc_INT-EN.rfa</i></p>	
0188642	<p>DB206H125 distribution box 200 series <i>VE_Distribution_Box_MEPcontent_Ubbink_Air_Excellent_DB206H125_INLINE_INT-EN.rfa</i></p> <p>Note: this article includes inline adaptor DN125, 3 caps and 6 air restrictor rings</p>	

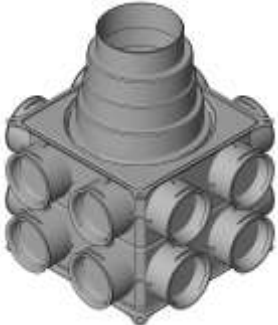
<p>0188633</p>	<p>DB206V180HE distribution box 200 series <i>VE_Distribution Box_MEPcontent_Ubbink_Air Excellent_DB212V180HE_INLINE_INT-EN.rfa</i></p> <p>Note: this article Includes stepped adaptor DN125-180, 6 caps and 12 air restrictor rings</p>	
<p>0188644</p>	<p>DBox206H distribution box 200 series <i>VE_Distribution Box_MEPcontent_Ubbink_Air Excellent_DB206H125_INT-EN.rfa</i></p> <p>Note: this article Includes stepped adaptor DN125-180, 6 caps and 12 air restrictor rings</p>	
<p>0188646</p>	<p>DB208V180 distribution box 200 series <i>VE_Distribution Box_MEPcontent_Ubbink_Air Excellent_DB208V180_INT-EN.rfa</i></p> <p>Note: this article includes stepped adaptor DN125-180, 4 caps and 8 air restrictor rings</p>	
<p>0188631</p>	<p>DB208V180VE distribution box 200 series <i>VE_Distribution Box_MEPcontent_Ubbink_Air Excellent_DB216V180VE_INT-EN.rfa</i></p> <p>Note: this article includes stepped adaptor DN125-180, 8 caps and 16 air restrictor rings</p>	

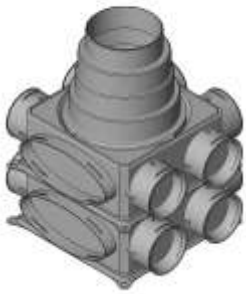
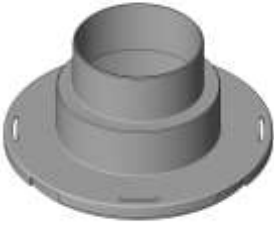
0188630	<p>DBOX212H distribution box 200 series <i>VE_Distribution Box_MEPcontent_Ubbink_Air Excellent_DB212H125_INT-EN.rfa</i></p> <p>Note: this article includes stepped adaptor DN125-180, 6 caps and 12 air restrictor rings</p>	
0188637	<p>Stepped Adaptor 100-125 <i>VE_Connection Piece_Round_MEPcontent_Ubbink_Air Excellent_Stepped Adapter 100-125_INT-EN.rfa</i></p>	
0188565	<p>Stepped Adaptor 125-150-160-180 <i>VE_Connection Piece_Round_MEPcontent_Ubbink_Air Excellent_Stepped Adapter 125-180_INT-EN.rfa</i></p>	